

NETWORK CAMERA SERIES

OPERATION GUIDE

Please read instructions thoroughly before operation and retain it for future reference.

IMPORTANT SAFEGUARD



All lead-free products offered by the company comply with the requirements of the European law on the Restriction of Hazardous Substances (RoHS) directive, which means our manufacture processes and products are strictly "lead-free" and without the hazardous substances cited in the directive.



The crossed-out wheeled bin mark symbolizes that within the European Union the product must be collected separately at the product end-of-life. This applies to your product and any peripherals marked with this symbol. Do not dispose of these products as unsorted municipal waste. Contact your local dealer for procedures for recycling this equipment.



This is a class A product. In a domestic environment this product may cause radio interference in which case the user may be required to take adequate measures.

Federal Communications Commission Interference Statement

This equipment has been tested and found to comply with the limits for a Class A digital device, pursuant to Part 15 of the FCC Rules. These limits are designed to provide reasonable protection against harmful interference when the equipment is operated in a commercial environment. This equipment generates, uses, and can radiate radio frequency energy and, if not installed and used in accordance with the instruction manual, may cause harmful interference to radio communications. Operation of this equipment in a residential area is likely to cause harmful interference in which case the user will be required to correct the interference at his own expense.

This device complies with Part 15 of the FCC Rules. Operation is subject to the following two conditions:

- (1) This device must not cause harmful interference, and
- (2) This device must accept any interference received, including interference that may cause undesired operation.

Trademark Acknowledgements

iPad® & iPhone® are the registered trademarks of Apple Inc.

Android™ is a trademark of Google Inc. Use of this trademark is subject to Google Permissions.

Microsoft®, Windows® & Internet Explorer® are registered trademarks of Microsoft Corporation in the United States and/or other countries.

Disclaimer

We reserve the right to revise or remove any content in this manual at any time. We do not warrant or assume any legal liability or responsibility for the accuracy, completeness, or usefulness of this manual. The content of this manual is subject to change without notice.

This product doesn't have a standby / off mode.

MPEG4 Licensing

THIS PRODUCT IS LICENSED UNDER THE MPEG4 VISUAL PATENT PORTFOLIO LICENSE FOR THE PERSONAL AND NON-COMMERCIAL USE OF A CONSUMER FOR (i) ENCODING VIDEO IN COMPLIANCE WITH THE MPEG4 VISUAL STANDARD ("MPEG-4 VIDEO") AND/OR (ii) DECODING MPEG4 VIDEO THAT WAS ENCODED BY A CONSUMER ENGAGED IN A PERSONAL AND NON-COMMERCIAL ACTIVITY AND/OR WAS OBTAINED FROM A VIDEO PROVIDER LICENSED BY MPEG LA TO PROVIDE MPEG4 VIDEO. NO LICENSE IS GRANTED OR SHALL BE IMPLIED FOR ANY OTHER USE. ADDITIONAL INFORMATION INCLUDING THAT RELATING TO PROMOTIONAL INTERNAL AND COMMERCIAL USES AND LICENSING MAY BE OBTAINED FROM MPEG LA, LLC. SEE [HTTP://WWW.MPEGLA.COM](http://www.mpegla.com).

GPL Licensing



This product contains codes which are developed by Third-Party-Companies and which are subject to the GNU General Public License ("GPL") or the GNU Lesser Public License ("LGPL").

The GPL Code used in this product is released without warranty and is subject to the copyright of the corresponding author.

Further source codes which are subject to the GPL-licenses are available upon request.

We are pleased to provide our modifications to the Linux Kernel, as well as a few new commands, and some tools to get you into the code. The codes are provided on the FTP site, and please download them from the following site or you can refer to your distributor:

http://download.dvrtw.com.tw/GPL/076D_Series/arm-linux-2.6.tar.gz

TABLE OF CONTENTS

1. OVERVIEW.....	1
1.1 Product Features.....	1
1.2 Package Content.....	1
1.3 Cable Overview.....	1
2. CAMERA ACCESS WITH INTERNET EXPLORER.....	2
2.1 Camera Login.....	2
2.2 Control Panel Overview.....	2
2.3 Digital PTZ (DPTZ) Operations.....	4
2.4 Event Record Search & Playback.....	5
3. CAMERA CONFIGURATIONS.....	6
3.1 System configuration menu.....	6
3.2 Network.....	7
3.2.1 Network.....	7
3.2.2 QoS.....	7
3.2.3 DDNS.....	7
3.2.4 SNTP.....	8
3.2.5 FTP.....	8
3.2.6 MAIL.....	8
3.2.7 SMS.....	9
3.2.8 Filter.....	10
3.2.9 UPnP / Bonjour.....	10
3.2.10 RTP.....	11
3.3 Camera.....	12
3.3.1 Camera.....	12
3.3.2 Video.....	12
3.3.3 Color.....	13
3.3.4 Advance.....	13
3.4 Record.....	14
3.4.1 Record.....	14
3.4.2 Record Timer.....	14
3.5 Storage.....	14
3.5.1 Memory.....	14
3.6 Trigger.....	15
3.6.1 Trigger.....	15
3.7 General.....	16
3.7.1 General.....	16
3.7.2 Time.....	16
3.7.3 Server Log.....	17
3.7.4 Online.....	17
3.7.5 Account.....	18
3.7.6 Google Maps.....	18
3.7.7 Maintenance.....	19
APPENDIX 1 PRODUCT SPECIFICATIONS.....	21
APPENDIX 2 BIT RATE TABLE FOR REFERENCE.....	22
APPENDIX 3 POE CONNECTION.....	24
APPENDIX 4 API ID APPLICATION FOR SMS MESSAGING.....	25
APPENDIX 5 Q&A.....	27
APPENDIX 6 RECORDING TIME TABLE.....	28

1. OVERVIEW

1.1 Product Features

- Easy network setup with your iPhone / iPad
- ONVIF standard supported to simplify system integration
- POE (Power-over-Ethernet) support to eliminate the use of power cables and reduce installation costs
- External alarm I/O device connection
- Remote Surveillance
 - Fully compatibility on iPhone & iPad, and Internet Explorer® on Windows® operating system
- 35 IR LEDs built-in for night surveillance
- 1.3 Megapixel with HDTV 720p quality, allowing users to notice minor details more easily

1.2 Package Content

<input type="checkbox"/> Network camera	<input type="checkbox"/> Bracket	<input type="checkbox"/> Quick Setup with iPhone / iPad
---	----------------------------------	---

1.3 Cable Overview

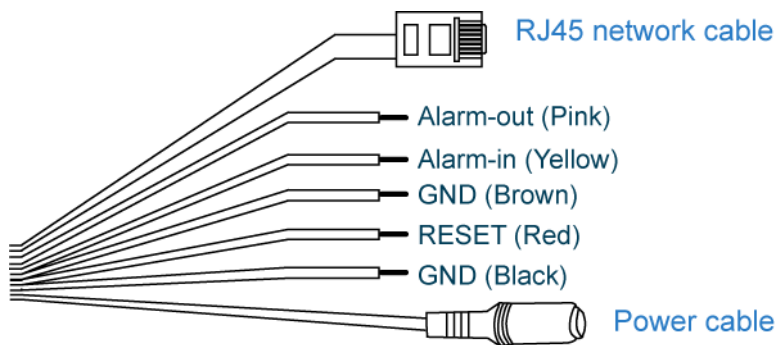

Color	Cable	Description
--	Power cable	Connect to DC12V power supply. Note: The power adapter is optional.
--	RJ45 network cable	Connect it to the supplied RJ45 cable extender adapter for cable extension, and prepare another RJ45 network cable with suitable length for your connection.
Black & Brown	GND	Ground wire, used for reset default or external device connection.
Yellow	Alarm-in	Reserved for connecting to an external alarm device. For details, please refer the user manual of your alarm device.
Pink	Alarm-out	Reserved for connecting to an external alarm device. For details, please refer the user manual of your alarm device.
Red	RESET	Remove the insulating coating of this wire, and twist it with a ground wire together to reset default. This will reset all parameters, including the IP address to factory default settings. Note: Disconnect power before twisting these two wires together, and connect to power again for reset default.

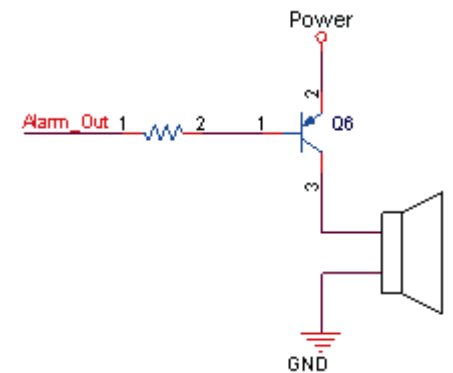

2. CAMERA ACCESS WITH INTERNET EXPLORER

This network camera can be accessed via Microsoft® Internet Explorer® and iPhone / iPad / Android mobile devices with our self-developed program “EagleEyes” installed depending on different using situations.

Note: For details about accessing network cameras via iPhone / iPad / Android mobile devices, please refer to <http://www.eagleeyesccvt.com>.

Before using the camera, make sure you have configured the network settings, and the network connection is fine.

For network configurations, please refer to:

- “Quick Setup With iPhone / iPad” supplied with your camera if you’re using iPhone / iPad, and your network environment is wireless.
- “ADVANCED NETWORK SETUP” downloadable from www.surveillance-download.com/user/m357a.swf if your network environment is not wireless.

2.1 Camera Login

Step1: Open your web browser, and key in <http://ipaddress:portnum> in the URL address box.

For example, for the IP address 60.121.46.236 and port No. 888, please key in “<http://60.121.46.236:888>” into the URL address box, and press “Enter”.

Step2: In the login page, key in the user name and password, and enter the security code from the image below if any. Then, click “LOGIN”.

Step3: The wizard is then started.

- To skip the wizard and directly access the camera live view, click “Close”.
- To directly access the camera live view without starting the wizard for the login next time, check “Do not start wizard at login”.









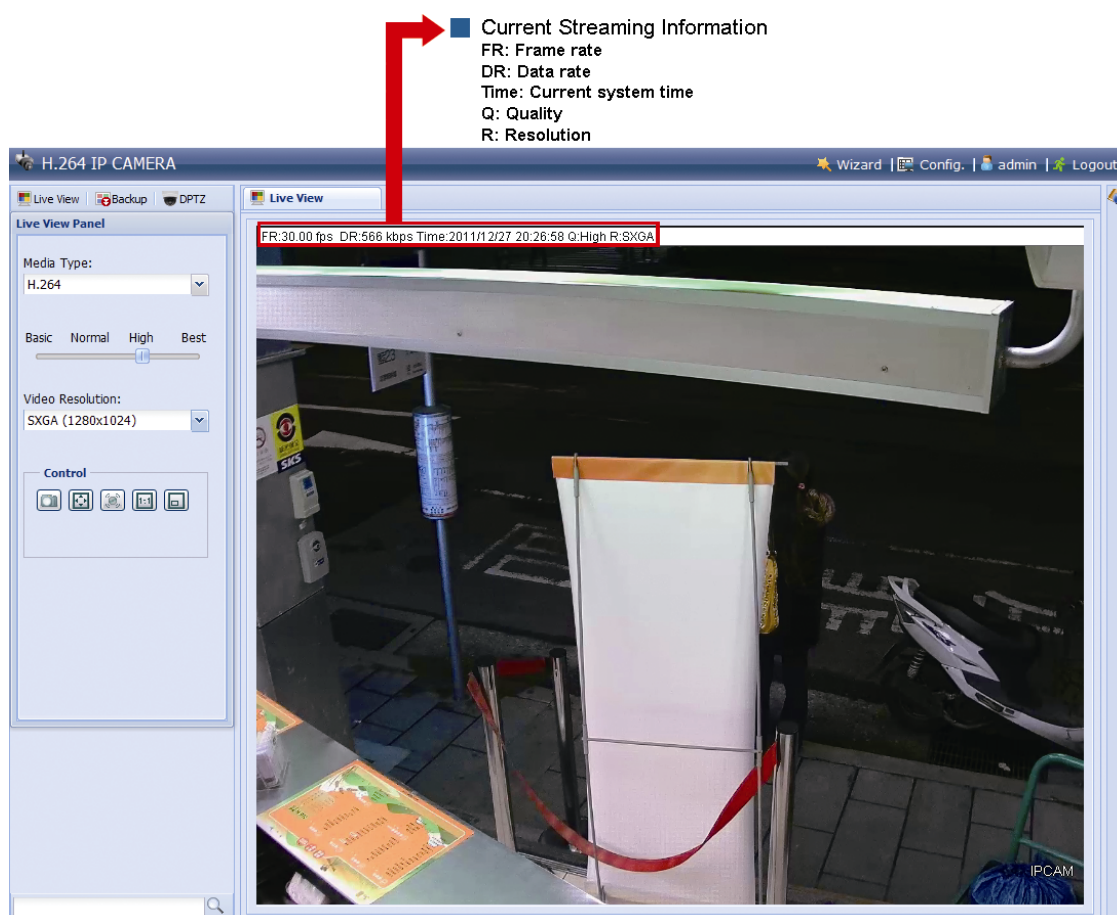

Note: If you’re prompted to install “VLC player”, “Software” and “H264 Streaming Viewer”, please agree to proceed the installation.

Step5: When the login is successful, the live view is shown.

2.2 Control Panel Overview

Note: The buttons available depend on the user level used to log in.



Function	Icon	User Level	Description
Live		Supervisor / Power User / Normal User / Guest	Switch to the live view page.
DPTZ		Supervisor / Power User / Normal User	Switch to the DPTZ configuration page. For details, please refer to "2.3 Digital PTZ (DPTZ) Operations" at page 4.
Backup		Supervisor / Power User	Enter the event record list for video playback. For details, please refer to "2.4 Event Record Search & Playback" at page 4.
Config.		Supervisor / Power User	Switch to the system configuration page, and the functions available for "Supervisor" and "Power User" are different. For details, please refer to "3.1 System configuration menu" at page 6.
Media Type	--	Supervisor / Power User / Normal User / Guest	Select the image player from the drop-down list: <ul style="list-style-type: none"> ■ H.264 / MPEG-4 / Motion JPEG ■ QuickTime <p>QuickTime is Apple Inc.'s multimedia software. You need to have QuickTime installed in your operating system before selecting "QuickTime". When it is selected, you will be promoted to enter the user name and password to access the camera.</p> <ul style="list-style-type: none"> ■ VLC
Quality	--	Supervisor / Power User / Normal User	Click & drag the slider to select the video quality: BASIC / NORMAL / HIGH / BEST.
Video Resolution	--	Supervisor / Power User / Normal User	Select the image resolution from the drop list: <ul style="list-style-type: none"> ■ SXGA (1280 x 1024) ■ HD720P (1280 x 720) ■ VGA (640 x 480) ■ QVGA (320 x 240)
Live View Size:		Supervisor / Power User / Normal User	
Full Screen			Click to display the image in full screen. To exit the full screen mode, press "Esc" on your keyboard. <i>This icon appears only when the selected resolution is SXGA, HD720P & VGA.</i>
Double size			The QVGA resolution is resized to fit into the current live view size. <i>This icon appears only when the selected resolution is QVGA.</i>
Normal Size			The current live view size is the same as the selected resolution. <i>This icon appear only when the selected resolution is SXGA or HD720P.</i>
Fit to screen			The selected resolution is resized to fit into the current live view size. <i>This icon appear only when the selected resolution is SXGA or HD720P.</i>
No Scale			Click and hold the movable square on the left bottom corner of the live view to move <i>This icon appear only when the selected resolution is SXGA or HD720P.</i>
Snapshot		Supervisor / Power User / Normal User	Click to take a snapshot of the current view on a new window. Right click on the picture and re-save it to the location you want.
Alarm Out		Supervisor / Power User / Normal User	Click to force your alarm-out device to work. For example, when your alarm device is a buzzer, click this button and your buzzer will start to sound even if there's no alarm event.

2.3 Digital PTZ (DPTZ) Operations

This camera has PTZ capability, i.e. digital PTZ (hereafter called “DPTZ”), for wide area monitoring.

STEP1: Click “DPTZ” to show the DPTZ control panel.

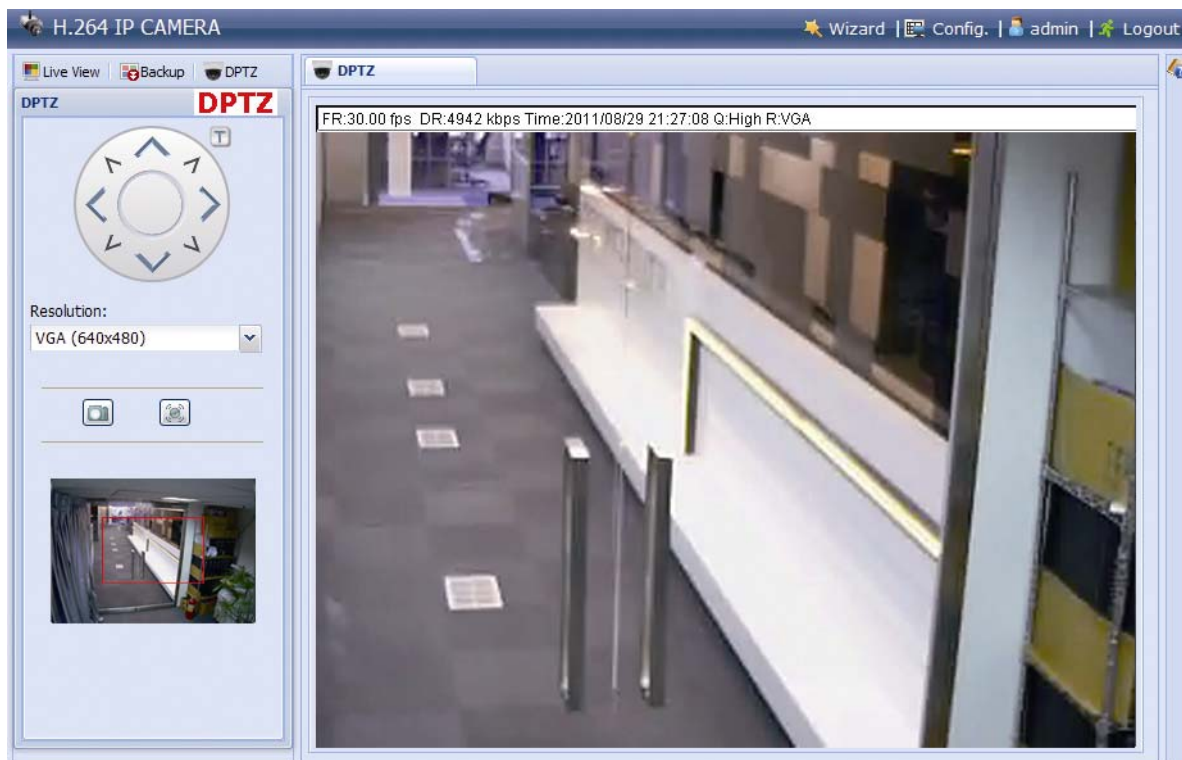

STEP2: Select the functions when needed:

FUNCTION	ICON	DESCRIPTION
Resolution	--	Select the video resolution for the DPTZ function. Only “VGA” and “QVGA” are available.
Take snapshots		Click to take a snapshot of the current view on a new window. Right click on the picture and re-save it to the location you want.
Alarm Out		Click to force your alarm-out device to work. For example, when your alarm device is a buzzer, click this button and your buzzer will start to sound even if there’s no alarm event.

2.4 Event Record Search & Playback

This camera can only save up to three alarm recordings.

Note: To save more recorded data, it's recommended to use this camera with the compatible NVR.

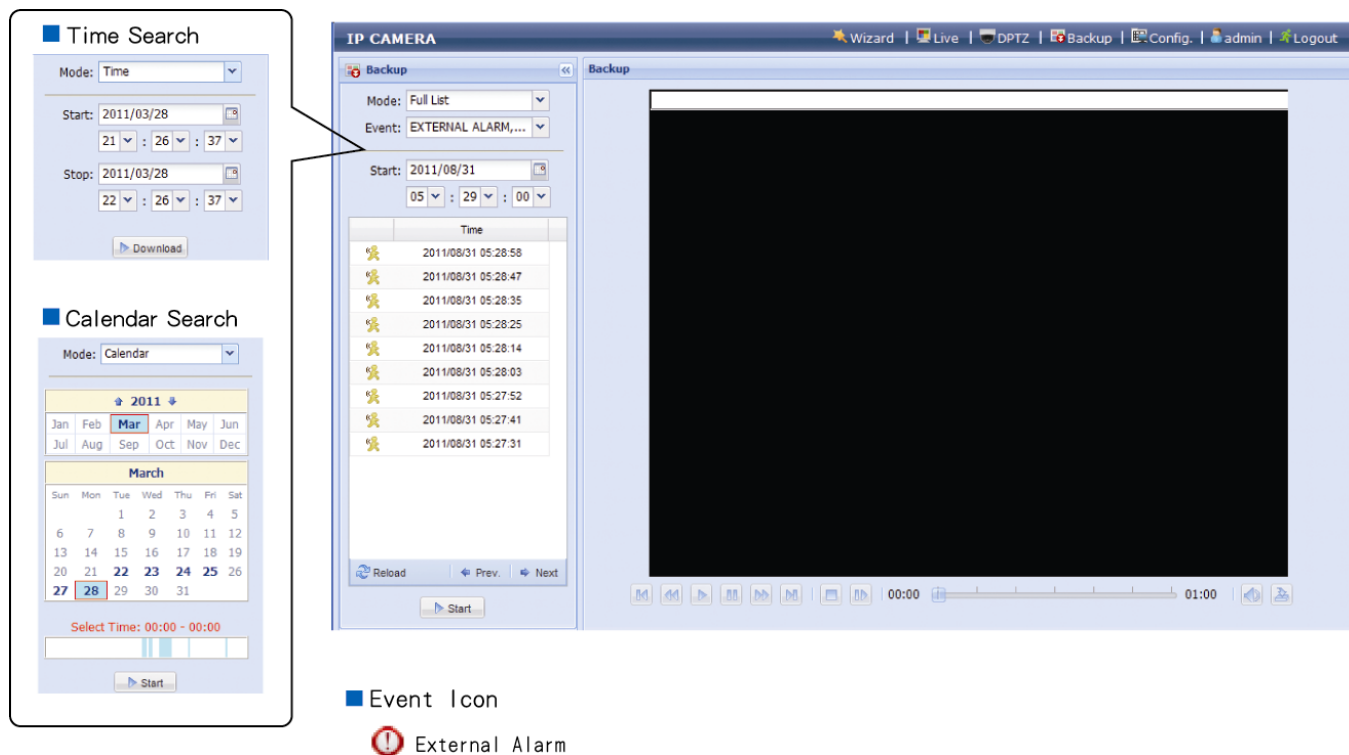

	Previous / Next Hour	Click to jump to the next / previous time interval in an hour, for example, 11:00 ~ 12:00 or 14:00 ~ 15:00, and start playing the earliest event video clip recorded during this whole hour.
	Fast Forward	Increase the speed for fast forward. Click to get 2X, 4X, 8X & 16X speed forward eventually.
	Fast Rewind	Increase the speed for fast rewind. Click to get 2X, 4X, 8X & 16X speed rewind eventually.
	Play	Click to play the current video clip.
	Pause	Click to pause the video playback.
	Stop	Click to stop the video playback.
	Step	In the pause mode, click to get one frame forward.
	Audio	Click to mute the playback if necessary, and click again to restore.
	Download	Click to download the current video clip to the specified path in your PC. <i>The downloaded video can only be opened by our own video player. Please go to "General" → "Maintenance" to download the video player, or get the player from the CD supplied with the sales package.</i>

3. CAMERA CONFIGURATIONS

Users can further configure this network camera by accessing via Internet Explorer.

3.1 System configuration menu

Click “Config.” to enter the configuration page.

The functions are categorized into six menus: Network, Camera, Record Timer, Storage, Trigger and General.

- For details about “Network”, please refer to “3.2 Network” at page 7.
- For details about “Camera”, please refer to “3.3 Camera” at page 12.
- For details about “Record”, please refer to “3.4 Record” at page 14.
- For details about “Storage”, please refer to “3.5 Storage” at page 14.
- For details about “Trigger”, please refer to “3.6 Trigger” at page 15.
- For details about “General”, please refer to “3.7 General” at page 16.

Main Menu	Sub-Menu	Reference
Network	Network	Configure network settings.
	QoS	Limit the data flow for live streaming.
	DDNS	Enter DDNS information when the network type is PPPOE or DHCP.
	SNTP	Synchronize your camera time with the networked computer systems.
	FTP	Enter the FTP information for event notifications when “FTP” is chosen in “Trigger” → “Trigger”.
	Mail	Enter Email information for event notifications when “Email” is chosen in “Trigger” → “Trigger”.
	SMS	Enter text messaging information for SMS notifications when “SMS” is chosen in “Trigger” → “Trigger”.
	Filter	Choose to permit or block the IP address(es) which can access this camera.
	UPnP	<i>*Suitable for Windows-based operating system.</i> Allow this camera to be detected among devices within the same network area for easy and quick usage.
	Bonjour	<i>*Suitable for Apple Mac-based operating system.</i> Allow this camera to be detected among devices within the same network area for easy and quick usage.
	RTP	Set the parameters for video data transmission when you’re using multimedia other than web browsers and Video Viewer for remote access.
Camera	Camera	1. Rename the camera. 2. Change the place where the camera name is shown on the screen.
	Video	Adjust video-related settings in different video format.
	Color	Adjust the color performance.
	Advance	Adjust the camera parameters if necessary.
Record	Record	Configure the record function.
	Record Timer	Schedule external alarm recording.
Storage	Memory	Check the current storage capacity and clear all recorded data when needed.
Trigger	Trigger	1. Enable / disable the motion detection. 2. Set the motion detection area. 3. Configure how the camera reacts for any event.

Main Menu	Sub-Menu	Reference
General	General	<ol style="list-style-type: none"> 1. Select the language of the web browser. 2. Check the MAC address of the camera. 3. Lock camera access after the specified time. 4. Enable or disable LED status indication.
	Time	Set daylight saving time and the current time.
	Server Log	Check the system event logs.
	Online	Check the current online user(s).
	Account	<ol style="list-style-type: none"> 1. Create a new user account with different access privilege. 2. Modify or delete an existing user account.
	Google Maps	Allow you to know where the network camera is.
	Maintenance	<ol style="list-style-type: none"> 1. Check the current firmware version and upgrade your camera. 2. Copy system configurations. 3. Reboot the camera. 4. Download the video player to play the recorded data.

3.2 Network

3.2.1 Network

You can set the network configuration of the network camera depending on your network type.

For details, please refer to “Advanced Network Setup” from www.surveillance-download.com/user/m357a.swf.

The screenshot shows the 'Network Configuration' web interface. It features several input fields and radio buttons. The 'IP Type' section has three options: 'Static IP', 'PPPoE', and 'DHCP', with 'DHCP' selected. Below this, there are fields for 'Server IP' (192.168.1.10), 'Gateway' (192.168.1.1), 'Net: Mask' (255.255.255.0), 'Port' (88), 'DNS1' (8.8.8.8), and 'DNS2' (168.95.1.1). A 'MAC Address' field shows '00:0E:53:E7:5B:8C'. At the bottom, there are 'Save' and 'Reload' buttons.

3.2.2 QoS

QoS, Quality of Service, is the ability to control the data flow for real-time streaming. This function is important if your network bandwidth is insufficient and you have other devices to share the network bandwidth.

Check “QoS Enable”, and set the max. upload rate from 256 to 10240 kbps.

The screenshot shows the 'QoS Configuration' web interface. It has two radio buttons for 'QoS': 'Enable' (selected) and 'Disable'. Below, there is a dropdown menu for 'Interface' set to 'Ethernet' and a text input field for 'Max. Upload Rate' set to '4096' kbps. 'Save' and 'Reload' buttons are at the bottom.

3.2.3 DDNS

Select “On” when the selected network type in “Network” is “PPPOE” or “DHCP”.

For details, please refer to “Advanced Network Setup” from www.surveillance-download.com/user/m357a.swf.

The screenshot shows the 'DDNS Configuration' web interface. It has two radio buttons for 'DDNS': 'Enable' and 'Disable' (selected). Below, there are three input fields: 'System Name' (eagleeyes), 'Hostname' (MAC00E53E75B8C) with a domain suffix '.ddns.eagleeyes.tw', and 'E-Mail' (manager@tech.com). 'Save' and 'Reload' buttons are at the bottom.

3.2.4 SNTP

SNTP (Simple Network Time Protocol) is used to synchronize your camera time with the networked computer systems.

Function	Description
GMT	Once users choose the time zone, the network camera will adjust the local area time of the system automatically.
NTP Server	Simply use the default SNTP server (For example, tock.stdtime.gov.tw) or change to another server with which users are familiar.
Sync. Period	Select "Daily" to synchronize the camera time with the network time every day or "None" to turn off this function.
Sync	Click and the network camera will synchronize the time with the network time.

3.2.5 FTP

Enter the detailed FTP information and click "Save" to confirm. The information you set here will be applied when "FTP" is selected in "Trigger" → "Trigger".

3.2.6 MAIL

Enter the detailed e-mail information and click "Save" to confirm. The information you set here will be applied when "Email" is selected in "Trigger" → "Trigger".

Function	Description
SMTP Server	Enter the SMTP server address provided from your e-mail system supplier.
Port	Enter the port number provided from your e-mail system supplier. If this column is left blank, the e-mail server will use port 25 to send e-mails.
Mail From	Enter the name of the sender.
SSL Encryption	Select "Yes" if your e-mail server is using SSL encryption to protect your e-mail content from unauthorized access.

Function	Description
Verify Password	Some mail servers are required to verify the password. Please enter the “user name” and “password”.
E-Mail Address List	Add the e-mail address(s) of the assigned recipient(s).
Test	When all information is entered, click “Test Mail” to try if the receipt.

3.2.7 SMS

Note: Before using this function, you need to apply an API ID from the mobile messaging company, Clickatell, and you will be charged starting from the 11th message. For details, please refer to “APPENDIX 4 API ID APPLICATION FOR SMS MESSAGING’ at page 25.

Enter the detailed information needed for text messaging, and click “Save” to confirm. The information you set here will be applied when “SMS” is selected in “General” → “Trigger”.

The screenshot shows the 'SMS Configuration' window. It contains the following fields and controls:

- System:** A dropdown menu with 'clickatell' selected.
- Username:** A text input field containing 'tech'.
- Password:** A text input field with masked characters '*****'.
- API ID:** A text input field containing '3281378'.
- Recipient:** A text input field containing '+886912665475' with a small flag icon to the left.
- Transfer Interval:** A dropdown menu with '15' selected, followed by the text 'Minute(s)'. A 'Reset Counter' button is located to the right of this dropdown.
- Message:** A text area containing '[192.168.1.10] unauthorized access!'. A checkbox labeled 'Include Hostname or IP' is checked.

At the bottom of the form, there are three buttons: 'Save', 'Test', and 'Reload'.

Function	Description
System	The text messaging service provider is Clickatell.
User name / Password	Enter the account user name and password you created in Clickatell.
API ID	Enter the API ID you applied from Clickatell.
Recipient	Click “Add” to enter the phone number, including the country code, to receive the text message. Five sets of phone numbers are allowed.
Transfer Interval	Set the interval time in minutes between two-message sending. The options are 0, 15, 30 & 60.
Reset Counter	Click to restart the text messaging, and the SMS will be sent after the specified time interval since you click this button.
Message	Enter the text content (up to 70 characters) you want to send with the text message.
Test	To know whether your SMS setting is correct, click this button to immediately send a SMS to your phone. Note: This testing is not free and you will be charged for SMS sending base on your local rate.

3.2.8 Filter

Choose to permit or block the IP address(es) which can access this camera, and click “Save” to confirm.

Function	Description
Filter Configuration	
Error Count	Set the maximum count for login failure. When the maximum count is reached, the IP address trying to access the network camera will be locked.
Error Lock Time	Set the lock time in minutes when the maximum count of error login for an IP address is reached.
Echo Request	Select “Non-Block” to allow other users to use the ping command to detect the IP address of your network camera, or “Block” to deny the ping command request.
IP/MAC Filter Configuration	
IP/MAC Filter	Choose to enable or disable the filter function.
IP/MAC Filter Policy	If “Enable” is selected, choose whether you want to permit (Allow) or block (Deny) the IP address list below.
IP/MAC Filter Rules	
Rule	<ul style="list-style-type: none"> To add an item to the IP address list, key in the IP address in “Rule”, and click “Add”. To remove an existing item in the IP address list, click the item you want to remove, and click “Delete”.

3.2.9 UPnP / Bonjour

“UPnP” stands for “Universal Plug and Play”, which allows devices to connect seamlessly in the home and corporate environments and simplify installation of computer components, and is only suitable for Microsoft Windows-based operating system.

“Bonjour” functions the same as “UPnP”, but it’s only suitable for Apple Mac-based operating system.

➤ UPnP

➤ Bonjour

Check “Enable” to allow the network camera to be detected among devices within the same network area, and set the identification name of the camera in “Friendly name”.

When this function is activated, the other PC within the same domain as this camera will be able to search this camera in:

- “Network Neighbor” with the identification name set in “Friendly name” for Windows-based PC, or
- “” (finder) or “Bookmark” with the identification name set in “Device Name” for Mac-based PC.

Double-click it to quickly open the web browser for camera access.

Port Mapping (Available only in UPnP)

This function can eliminate the need to additionally access the router for port forwarding.

For details, please refer to “Advanced Network Setup” from www.surveillance-download.com/user/m357a.swf.

Note: Before using this function, make sure your router supports UPnP, and this function is enabled. If not, please access your router additionally for port forwarding.

When “Port Mapping” is set to “Enable”, the system will automatically assign an IP address or port number for you if no IP address or port number is entered.

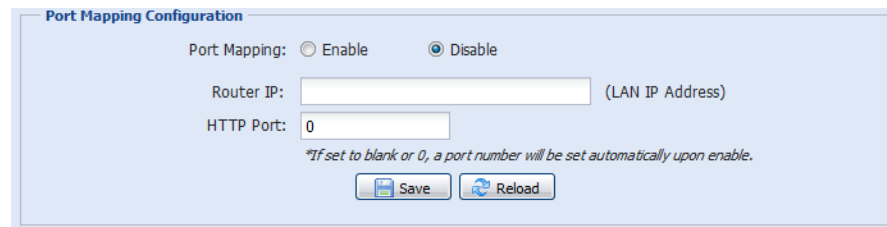

The screenshot shows the 'Port Mapping Configuration' window. It has a title bar 'Port Mapping Configuration'. Below the title bar, there are two radio buttons: 'Enable' (unselected) and 'Disable' (selected). Below the radio buttons, there are two input fields: 'Router IP:' with a text box and '(LAN IP Address)' label, and 'HTTP Port:' with a text box containing '0'. Below the input fields, there is a small italicized note: '*If set to blank or 0, a port number will be set automatically upon enable.' At the bottom of the window, there are two buttons: 'Save' and 'Reload'.

Note: When the configurations are saved successfully, you’ll see a message indicating the IP address and port number assigned to this network camera.

3.2.10 RTP

The Real-time Transport Protocol (RTP) is an Internet protocol standard to manage the real-time transmission of multimedia, such as VLC player.

The media player you want to use for remote access must support RTP transmission for this function to work normally.

Note: When you’re about to end the remote access, please press the stop button on your media player first, and then close the program. This is to ensure the server receives the stop command, and also help to protect the server from redundant data transmission.

Note: QQVGA is for mobile surveillance only.

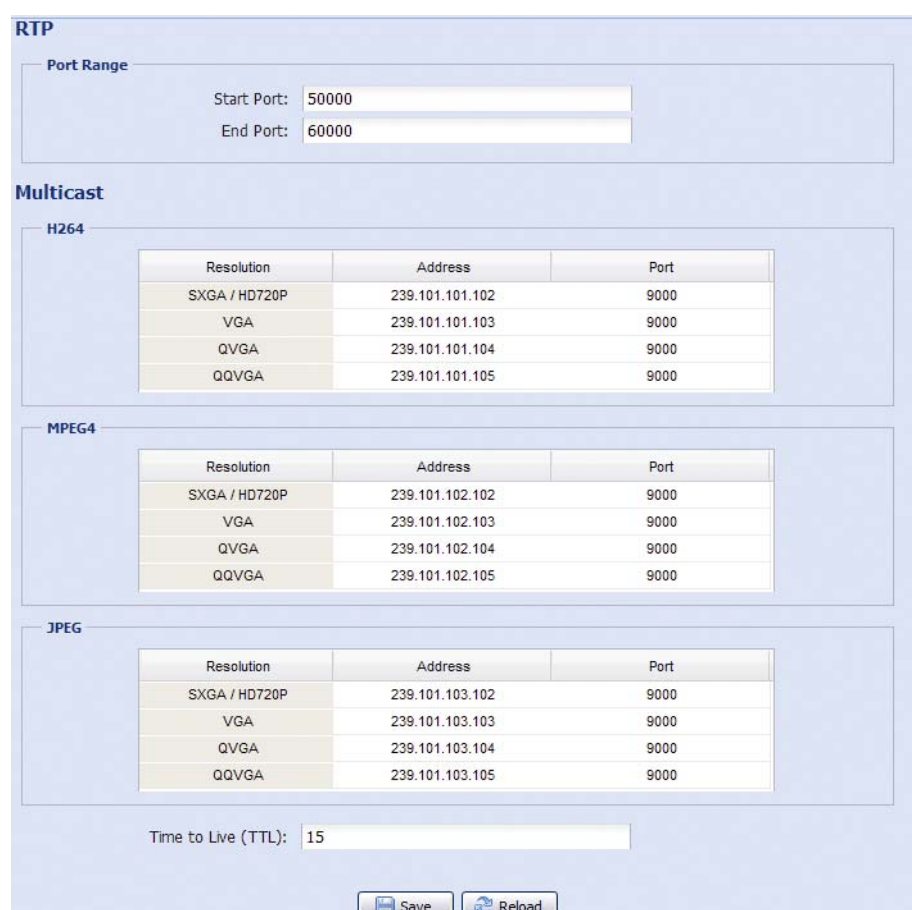

The screenshot shows the 'RTP' configuration interface. It has a title bar 'RTP'. Below the title bar, there is a section 'Port Range' with two input fields: 'Start Port:' with '50000' and 'End Port:' with '60000'. Below the 'Port Range' section, there is a section 'Multicast' with three sub-sections: 'H264', 'MPEG4', and 'JPEG'. Each sub-section contains a table with three columns: 'Resolution', 'Address', and 'Port'. The 'H264' table has rows for SXGA / HD720P, VGA, QVGA, and QQVGA. The 'MPEG4' table has rows for SXGA / HD720P, VGA, QVGA, and QQVGA. The 'JPEG' table has rows for SXGA / HD720P, VGA, QVGA, and QQVGA. At the bottom of the interface, there is a 'Time to Live (TTL):' input field with '15'. At the very bottom, there are two buttons: 'Save' and 'Reload'.

Function	Description
<ul style="list-style-type: none"> Port Range The port range used by RTP is limited, and preserving 100 ports between the start port and end port is necessary. 	
Start Port	The range of the start port is 1024 ~ 65434.
End Port	The range of the end port is 1124 ~ 65534.
<ul style="list-style-type: none"> Multicast 	
Address and port for H264 / MPEG4 / JPEG transmission	Set a specific address and port for multicast of each stream format (H264/ MPEG4/ JPEG). The range of the address is limited between 224.0.0.1 ~ 239.255.255.255. The port for multicast must be an even number.
Time to Live (TTL)	The range of Time to Live of the package is between 1 ~ 255. As soon as Time to Live of the package is 0, it will be dropped.

3.3 Camera

3.3.1 Camera

Rename the camera, and change the place where the camera name is shown on the screen, UP-LEFT / UP-RIGHT / DOWN-LEFT / DOWN-RIGHT.

3.3.2 Video

Adjust video-related settings in different video format.

- “Quality” is related to image clearness.
- “FPS” is related to the fluency of the video. The more the FPS, the more fluent the video.
- “Max Bit Rate” is the maximum limitation of data transmission in the selected image format and resolution.

Note: QQVGA is for mobile surveillance only.

Configuration			
Power Line Frequency:	60	Hz	
H264			
Resolution	Quality	FPS	Max Bit Rate
SXGA / HD720P	HIGH	30	5000
VGA	HIGH	30	3000
QVGA	HIGH	30	3000
QQVGA	HIGH	30	3000
MPEG4			
Resolution	Quality	FPS	Max Bit Rate
SXGA / HD720P	HIGH	20	5000
VGA	HIGH	30	3000
QVGA	HIGH	30	3000
QQVGA	HIGH	30	3000
JPEG			
Resolution	Quality	FPS	
SXGA / HD720P	HIGH	30	
VGA	HIGH	30	
QVGA	HIGH	30	
QQVGA	HIGH	30	

3.3.3 Color

Adjust the color performance from Brightness, Contrast, Hue and Saturation. Click and drag the slider to preview the color change on the right side of this page and adjust the image color.

To restore the default values, click "Back to Default".

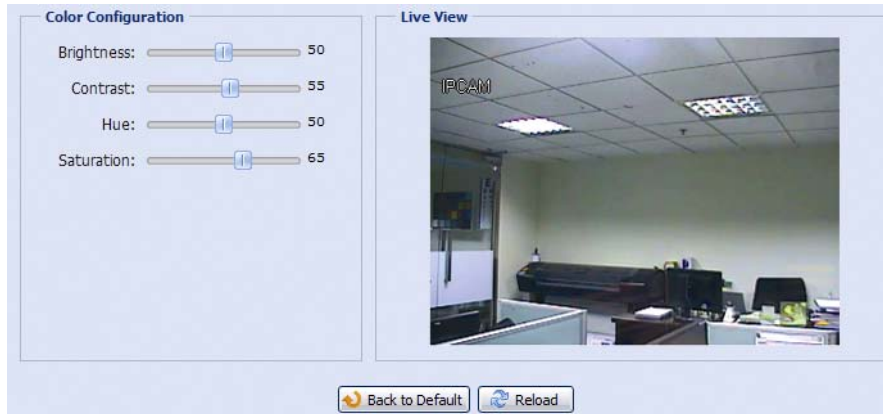

3.3.4 Advance

Adjust the camera parameters if necessary.

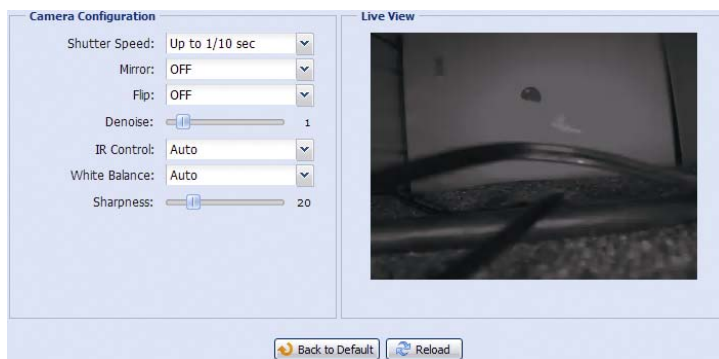

Item	Description
Shutter Speed	Set the shutter speed based on your need. The options are: Up to 1/10 sec, Up to 1/30, Up to 1/15, Up to 1/6, Up to 1 and Up to 2.
Mirror	Select "ON" to rotate the images horizontally based on your installation situation when necessary.
Flip	Select "ON" to rotate the image 180° when necessary.
De-noise	Click and drag the slider to adjust the level from 0 ~ 10 to decrease the noise shown in the dark environment.
IR Control	Select "Auto" to automatically enable IR LEDs at night or in the dark environment, "On" to always enable IR LEDs, or "OFF" to disable this function.
White Balance	Process the current image to retain color balance over a color temperature range. The options are: Auto, Incandescent Light, Cool Light, sun Light, Cloudy & Sun Shade.
Sharpness	Sharpness enhances the clarity of image detail by adjusting the aperture and sharpening the edges in the pictures. Hold and drag the slider to adjust the level of sharpness from 0 ~ 100. The higher the value, the sharper the image.

3.4 Record

3.4.1 Record

In “Record Configuration”, you can:

- Enable or disable the alarm record function. When “Enable” is set to “No”, the alarm record function is disabled even if you enable it in other configuration pages.
- Select if the data should be overwritten when the memory storage is full.
- Select the video resolution for event recording.

Note: The higher resolution you choose, the more accuracy and higher image quality the recording will be, but the faster the memory storage is consumed and become full.

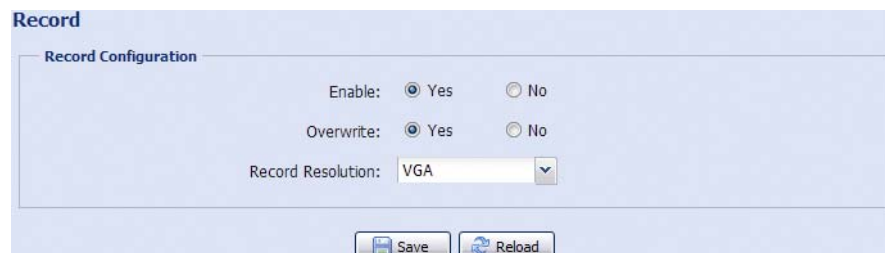

3.4.2 Record Timer

To schedule alarm recording, enable it, and select the day and time for recording.

Note: The timer must be enabled for the record function to work properly.

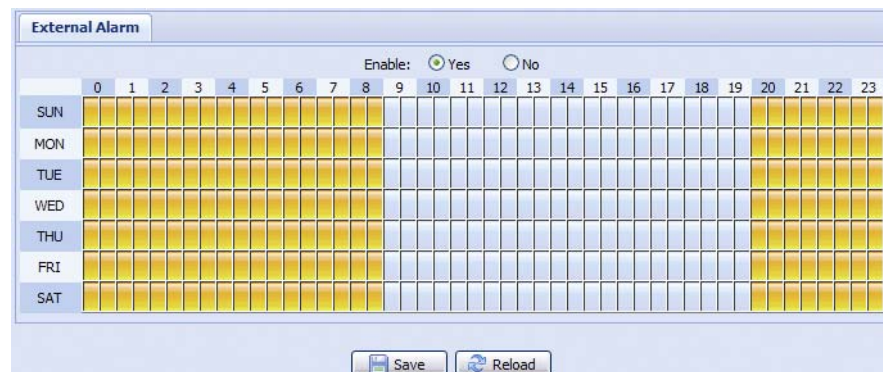

3.5 Storage

3.5.1 Memory

In “Memory”, you can check the remaining capacity for recording, or clear all recorded data saved if needed.

Note: The recorded data will be removed also when you reset or reboot this camera.

This camera can only save up to three alarm recordings.

Note: To save more recorded data, it's recommended to use this camera with the compatible NVR.

Note: To know the total recording time per recording resolution, please refer to “APPENDIX 6 RECORDING TIME TABLE” at page 28.

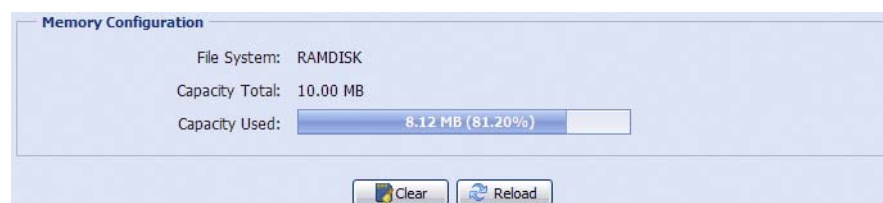

3.6 Trigger

3.6.1 Trigger

You can configure how this camera reacts when there's an alarm or motion event.

◆ Detect

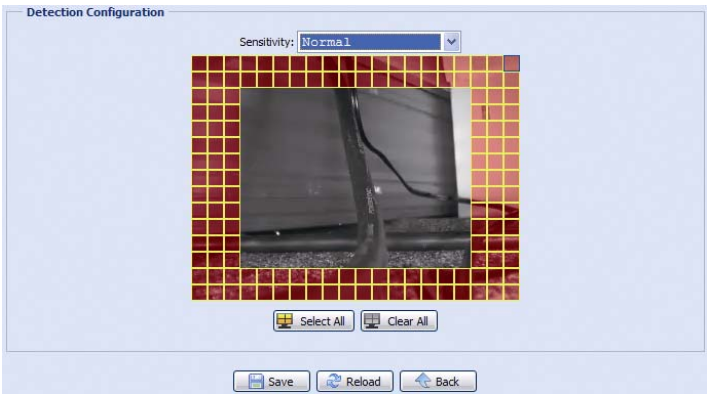
Item	Description
External Alarm	Enable or disable detection from external alarm-in device, and click the title "External Alarm" (in blue) to set "N.O." or "N.C." depending on the configuration of your alarm-in device.
Motion	<p>Enable or disable motion detection.</p> <p><i>Motion detection is not supported when the stream format is Motion JPEG.</i></p> <p>When "Enable" is selected, click "Detection" to enter the motion detection area setting page as follows:</p>  <p>Sensitivity: Set the detection sensitivity from the drop-down list: High, Normal or Low.</p> <p>Area Setting: Set the motion detection area by selecting the area grids with your mouse. Pink grids represent the area that is not being detected while the transparent grids are the area under detection. You can set multiple areas under detection. Click "Clear All" to set the whole area undetected. Click "Select All" to set the whole area under detection.</p>
Duration	Set the duration time for trigger recording (5 / 10 / 20 / 40 seconds).

◆ Action

Here defines how the camera delivers alerts to you for any event.

Item	Description
E-Mail	Select the event type you want to receive E-mail notifications when it occurs. Then, click the title "E-Mail" (in blue) to configure the media type (H264 / JPEG / MPEG4), file format (AVC / AVI), and record time (1 ~ 5 seconds) for the event video clip. The camera will send the captured video clip to the E-mail address(s) you assigned in "Network" → "Mail" once the selected event type occurs.
FTP	Select the event type you want to receive FTP notifications when it occurs. Then, click the title "FTP" (in blue) to configure the media type (H264 / JPEG / MPEG4), file format (AVC / AVI), and record time (1 ~ 5 seconds) for the event video clip. The camera will upload the captured video clip to the FTP site you assigned in "Network" → "FTP" once the selected event type occurs.
SMS	Select the event type you want to receive a text message when it occurs. The camera will send a text message to the mobile phone number you assigned in "Network" → "SMS" once the selected event type occurs.
Alarm Out	Select the event type you want to trigger the alarm-out device to work when it occurs. Then, click the title "Alarm Out" (in blue) to configure the trigger rule (LOW / HIGH).
Record	Select the event type you want to enable event recording when it occurs.

3.7 General

3.7.1 General

To change the language of UI interface, select from the drop-down list in "Language".

To lock camera access when it's not used after the specified time, select "5 MIN", "15 MIN" or "30 MIN" from the drop-down list of "Auto Lock Time", or select "NEVER" to disable this function.

Note: When the camera access is locked after the specified time, to resume camera access, please enter the password.

The screenshot shows the 'General Configuration' section of a web interface. It includes a 'Language' dropdown menu set to 'English', an 'Auto Lock Time' dropdown menu set to '5 MIN', and a 'MAC Address' field with the value '00:0E:53:E6:0D:90'. At the bottom of the configuration area, there are two buttons: 'Save' and 'Reload'.

3.7.2 Time

Set daylight saving time and the current time, and click "Save" to confirm.

The screenshot shows the 'Time Configuration' section of a web interface. It includes an 'OSD' section with radio buttons for 'Enable' and 'Disable' (selected). Below that is a 'Date' field set to '2011/08/30' and a 'Time' field set to '21:16:41'. The 'Daylight Saving Time Configuration' section includes radio buttons for 'Enable' and 'Disable' (selected). It also has fields for 'Start Time' (August, First Week, Monday, 6:00), 'End Time' (October, Fifth Week, Monday, 10:00), and 'Adjust Time' (1:00). At the bottom, there are 'Save' and 'Reload' buttons.

Function	Description
■ Time Configuration	
Date	Set the current date.
Time	Set the current time.
■ Daylight Saving Time Configuration	
Daylight Saving Time	Specify whether to use daylight saving time (Enable / Disable). If this function is enabled, set the time period (Start Time / End Time), and adjust the daylight saving time in hours (Adjust Time).

3.7.3 Server Log

To quickly search the system logs you want by event type, click “Prev. Page” or “Next Page” to find the logs you want, or check the event type(s) and click “Reload” to start searching.

To clear all system event logs, click “Clear All”.

Server Log List

No.	Event	Time	Result
1	Remote Login	2011/08/30 20:54:41	admin
2	Remote Login	2011/08/30 20:29:58	admin
3	Remote Login	2011/08/30 18:22:08	admin
4	SNTP Update	2011/08/30 18:20:06	Failed
5	Remote Login	2011/08/30 18:20:03	admin
6	Power On	2011/08/30 18:19:24	ON
7	Power On	2011/08/30 18:18:46	OFF
8	Remote Login	2011/08/30 18:11:21	admin
9	Remote Login	2011/08/30 18:11:18	admin
10	Remote Login	2011/08/30 18:07:10	admin
11	Remote Login	2011/08/30 18:03:19	admin
12	Remote Login	2011/08/30 18:02:15	admin
13	Remote Login	2011/08/30 18:02:07	admin
14	Remote Login	2011/08/30 18:01:51	admin
15	Remote Login	2011/08/30 17:57:01	admin
16	Remote Login	2011/08/30 17:56:55	admin
17	Remote Login	2011/08/30 17:56:53	admin
18	Remote Login	2011/08/30 17:54:44	admin
19	SNTP Update	2011/08/30 17:50:48	Failed
20	Power On	2011/08/30 17:50:07	ON

3.7.4 Online

You can check the current online user(s) with respective online information. To refresh the list, click “Reload”.

- To allow anonymous login, select “Enable” in “Anonymous Viewer Login”.
- To disable image code verification at login, select “No” in “Login with CAPTCHA Image”.

Online Configuration

Anonymous Viewer Login: Enable Disable

Login with CAPTCHA Image: Yes No

Max Online User:

Username	IP Address	User Level	Media Type
admin	211.75.84.96	SUPERVISOR	H264
admin	60.248.97.4	SUPERVISOR	H264

3.7.5 Account

You can create a new account with different user access privilege, or delete or modify an existing account setting.

How to create a new account

Step1: Click “New”, and fill in the following columns.

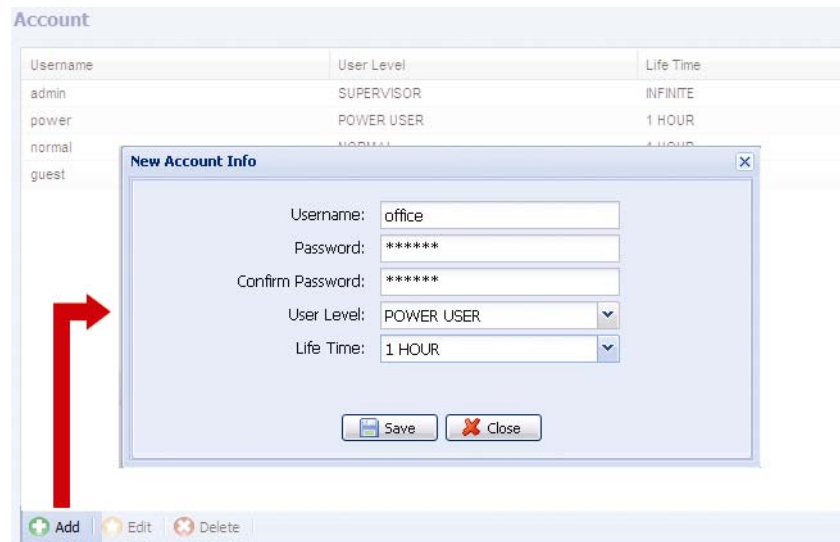

Column	Description
User Name	Set a user name that will be used for camera access. The user name allows up to 16 alphanumeric characters.
Password	Set the password that will be used for remote login. The password allows up to 16 alphanumeric characters.
Confirm Password	Enter the password again to confirm.
User Level	Set the security level of an account to give the permission to control different functions. There are four user levels: SUPERVISOR, POWER USER, NORMAL USER and GUEST.
Life Time	Select how long this account is allowed to stay online (1 MIN / 5 MIN / 10 MIN / 1 HOUR / 1 DAY / INFINITE)

Step2: Then, click “Save” to save your setting and create a new account.

How to modify or delete an existing account

Step1: Select the account you want to modify or delete.

Step2: To modify the account, click “Edit” to change the settings, and click “Save”.
To remove the account, click “Delete”.

Note: It’s not allowed to remove an account when there’s only one account in the account list.

3.7.6 Google Maps

This function is used to let you know where the network camera is.

The system will prompt you to apply a Google Maps Key if your access is denied. Please follow the instructions below when you’re denied:

Step1: Click “Sign up for a Google Maps key” to enter the application page.

Step2: Check the terms and conditions, and enter the IP address of the network camera. Then, click “Generate API Key”.

Step3: Copy the generated API key, and click “Update Google Maps Key” on the web browser to paste it.



3.7.7 Maintenance

Firmware Upgrade

This function is used when users need to upgrade the camera for function scalability.

Note: Before using this function, make sure you have the correct upgrade files provided by your installer or distributor.

Note: The event videos saved in the camera will be removed after firmware upgrade. Make sure you've copied important events to your PC before firmware upgrade.

Step1: Select “” to browse to where you save the upgrade files, and select them one by one until all files are selected (up to four files).

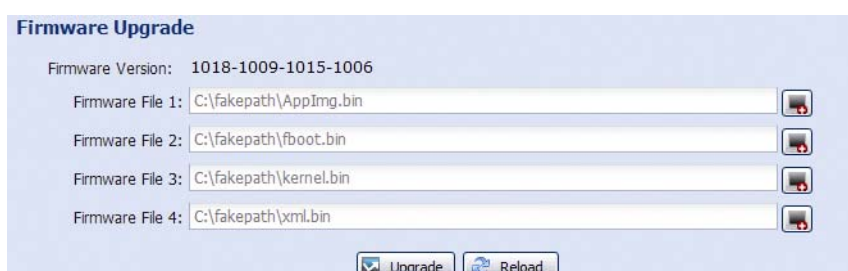

Step2: Select “Upgrade” to start system upgrading.

Note: You'll be prompted to keep current configurations. It's recommended to keep them, or all configurations will be restored to default values after upgrade.

Note: It takes a few minutes to finish the upgrade process. Do not disconnect the power during firmware upgrade, or the upgrade may be failed. The camera will reboot after the upgrade.

System Configuration Backup

This function is used to copy your system configuration to a "System.bin" file.

You may import the same system configuration to another camera, or restore your system configuration when the camera is reset to default values.

Select "System.bin" in "Firmware Upgrade", and select "Upgrade" to import the system configuration.

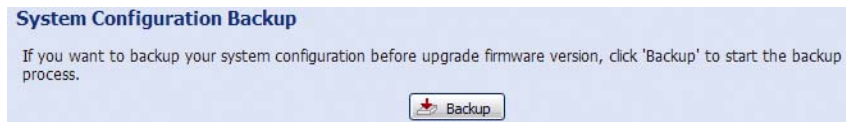

System Reboot

Select "Reboot" to restart your camera if needed.

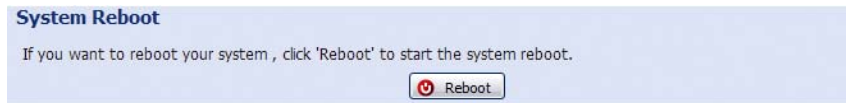

Player Download

To see the event video clips downloaded to your PC, you need to first install our own video player in your PC. Select "Free Download" to download the video player, and double click the file to install it.

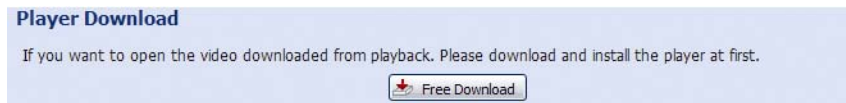

APPENDIX 1 PRODUCT SPECIFICATIONS

■ Network	
Network Compression	H.264 / MPEG4 / MJPEG
Multiple Video Streaming (Encode Modes, IPS, Resolution)	3 (H.264, MJPEG, MPEG4)
LAN Port	YES
LAN Speed	10/100 Based-T Ethernet
Supported Protocols	DDNS, PPPoE, DHCP, NTP, SNTP, TCP/IP, ICMP, SMTP, FTP, HTTP, RTP, RTSP, RTCP, IPv4, Bonjour, UPnP, DNS, UDP, IGMP
Frame Rate	NTSC:30, PAL:25
Number of Online Users	10
Security	(1) Multiple user access levels with password (2) IP address filtering (3) Digest authentication
Remote Access	(1) Internet Explorer® on Windows® operating system (2) EagleEyes on iPhone, iPad & Android mobile devices
■ Camera	
Image Sensor	1/4" SONY HR image sensor
Video Resolution	SXGA / HD720P / VGA / QVGA
Min Illumination	0.1 Lux / F1.5, 0 Lux (IR LED ON)
S/N Ratio	More than 48dB (AGC off)
Lens	f3.8mm / F1.5
Viewing Angle	62.7°(Diagonal)
IR LED	35 units
IR Effective Range	Up to 20 meters
IR Shift	YES
White Balance	ATW
AGC	Auto
IRIS Mode	AES
POE	YES (IEEE 802.3af)
IP Rating	IP67
External Alarm I/O	YES
Power Source (±10%)	12V / 1A
Operating Temperature	-20°C~40°C
Dimensions (mm)**	75(φ) x 114(H)
■ Others	
Mobile Surveillance	iPad, iPhone & Android mobile device
RTC (real-time clock)	YES
Motion Detection	YES
Event Notification	FTP / Email / SMS
Digital Pan / Tilt / Zoom	YES
Minimum Web Browsing Requirements	<ul style="list-style-type: none"> • Pentium 4 CPU 1.3 GHz or higher, or equivalent AMD • 256 MB RAM • AGP graphics card, Direct Draw, 32MB RAM • Windows 7, Vista & XP, DirectX 9.0 or later • Internet Explorer 7.x or later

* The specifications are subject to change without notice.

** Dimensional tolerance: ± 5mm

APPENDIX 2 BIT RATE TABLE FOR REFERENCE

The data below is for reference only.

The bit rates listed here may vary depending on the resolution, image quality & frame rate you choose, the complexity of your monitoring area, and how often the moving objects show in your monitoring area.

Testing Environment

- Place: Office Entrance
- Network translation: H.264
- Camera type: Megapixel camera

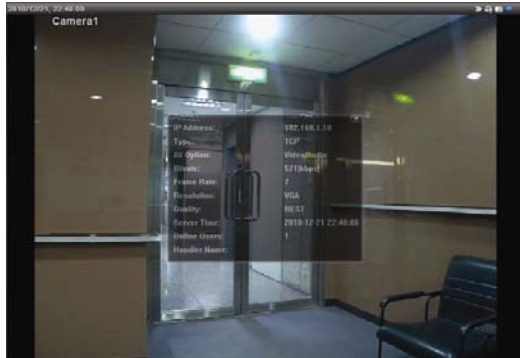

Static: No one coming in and out



Dynamic: One or two people coming in and out

Resolution	Quality	Frame Rate	(Dynamic) kbps	(Static) kbps	
SXGA	Best	FULL	3253	3216	
	High		2375	2160	
	Normal		1571	1266	
	Basic		1465	873	
VGA	Best		2010	1261	
	High		1042	1034	
	Normal		685	572	
	Basic		457	350	
QVGA	Best		646	366	
	High		482	350	
	Normal		302	286	
	Basic		168	161	
SXGA	Best		1/4	1163	1076
	High			989	715
	Normal			855	534
	Basic			719	443
VGA	Best	789		571	
	High	451		447	
	Normal	349		237	
	Basic	217		165	
QVGA	Best	269		147	
	High	182		131	
	Normal	164		113	
	Basic	97		71	

Resolution	Quality	Frame Rate	(Dynamic) kbps	(Static) kbps
SXGA	Best	1/15	581	374
	High		405	342
	Normal		487	248
	Basic		337	141
VGA	Best		358	79
	High		201	63
	Normal		180	28
	Basic		92	15
QVGA	Best		111	84
	High		99	68
	Normal		97	54
	Basic		58	42

APPENDIX 3 POE CONNECTION

This device supports PoE (Power-over-Ethernet), developed by the IEEE802.3af task force, and power can be supplied over the same network (Ethernet) cable as the one used to connect to Internet. No power cable is needed. Below shows two examples of POE application for reference.

- When your router / hub supports POE connection

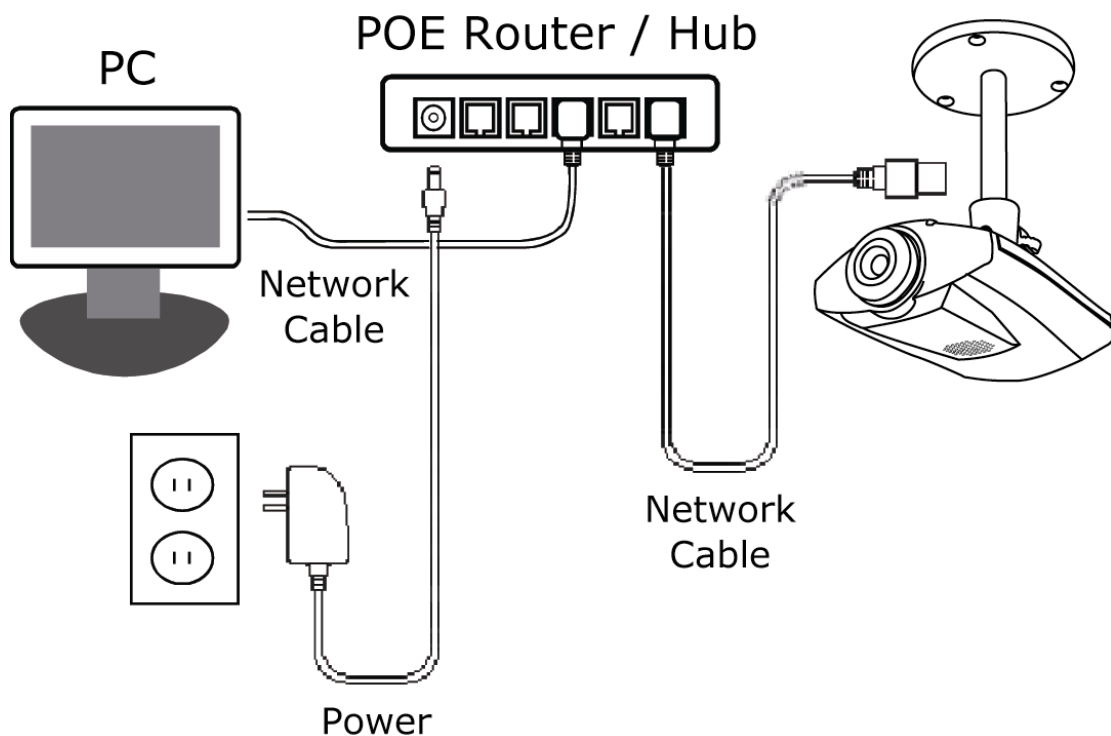

- When your router / hub doesn't support POE connection (An optional POE connected required)

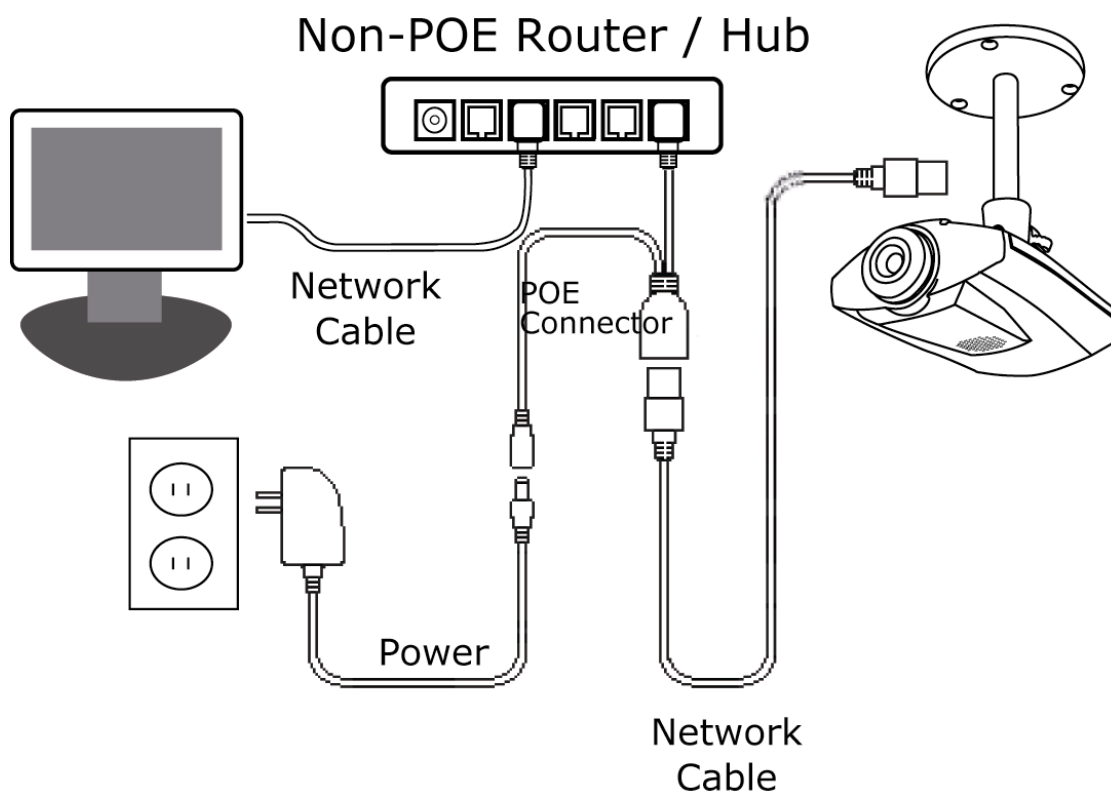

APPENDIX 4 API ID APPLICATION FOR SMS MESSAGING

To allow the camera automatically sending a text message when an event happens, you need to apply an API ID from Clickatell, one mobile messaging company, first.

Note: The SMS messaging is not totally free. You will be charged starting from the 11th message.

Please follow the steps below for application.

Step1: Go to <http://www.clickatell.com/login.php>. In “New Customers”, select “Clickatell Central (API)” from the drop-down list.

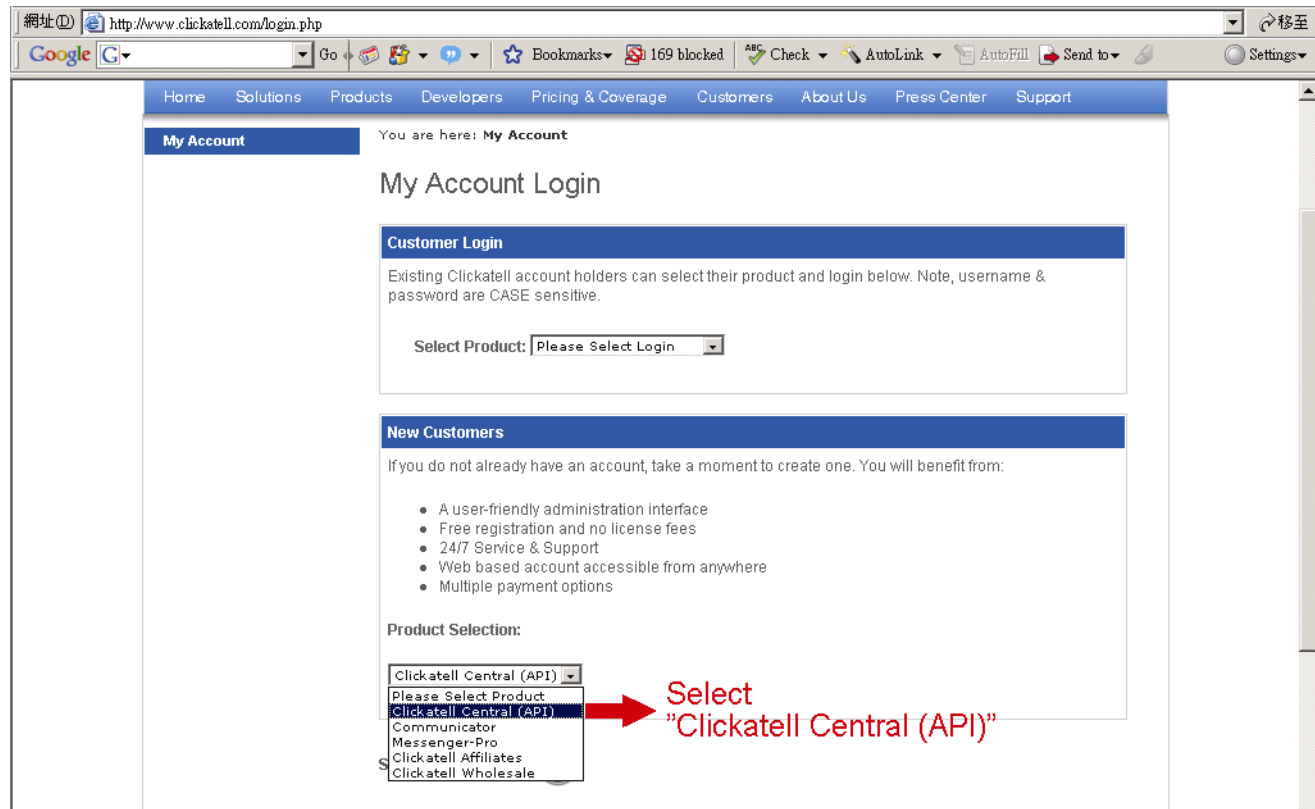

Step2: Fill in your information to create an account, and click “CONTINUE”.

Note: Note down the user name and password, and the mobile phone number you specified here for SMS notification setting later.

Step 1 of 4 - Select Product

Select one of the products below which you would like to register for:

Clickatell Central Communicator

Step 2 of 4 - Account Setup

Select a country specific or International account type, based on your requirements for SMS traffic delivery destinations.

International Coverage Account: Local Coverage Account:

INTERNATIONAL USA UK SA IN IE

* Create Username: Security Code: 

* Create Password: *Enter Security Code:

Step 3 of 4 - Personal Information

*First Name: *Country:

*Last Name: *Mobile Number:

*Email Address: (e.g. sample@domain.com)

Personal Use Only:

* Company: Job Description:

Company Size: Industry:

Subindustry:

Emails sent to me must be in Text format or HTML format

Please send me a weekly update of my account balance via email newsletter

* I accept Clickatell's [Terms and Conditions](#)

Step2: When the account is created, the system will automatically send an Email to your specified Email address and ask you to activate your account.

Click the link in the Email to complete account activation, and enter the login page as follows. Enter the password you set, and click “Login”.

My Account Login

Customer Login
Existing Clickatell account holders can select their product and login below. Note, username & password are CASE sensitive.

Select Product:

Username:

ClientID:

Password:

[Lost password?](#)

Enter the password you set to log in.

Step3: Enter the mobile phone number (including your country code) you want the text message to be sent, and click “SEND ACTIVATION CODE”. The system will send an activation code to that number for verification. Check if you receive a text message from Clickatell.

Verify your Mobile Number

For security reasons you are required to verify your mobile number with a non-test SMS messages.

Your activation code will be sent to

If this is not your number, please retype your mobile number in the box above and click the "Send Activation Code" button.

Enter your activation code here:

Enter your mobile phone number, including your country code.

Step4: Go back to Clickatell, and click the tab “Manage my Products”. Then, select “HTTP” from the drop-down list “My Connections”.

Central Home | My Settings | **Manage my Products** | Billing | Message Reports | Help

Manage my Products

Test Message in Message Box

My Connections: **My Connections**

Add Connection

HTTP

Select "HTTP".

Step5: In “Add HTTP API”, enter a descriptive name for this service, and make sure the dial prefix is correct and callback type is “HTTP GET”. Then, click “Submit”.

Add HTTP API - Bold Items Required

Name:

IP Lock Down:

Dial Prefix:

Callback Type:

Callback Url:

Callback Username:

Callback Password:

Minimum information required

Step5: You will get an API ID as follows.

Note: Note down the API ID for SMS notification setting later.

My Connections:

Name	Type	API ID	Dialing Code
IP_SMS	SMTP API	3218637	886 Taiwan
IP_MSG	HTTP	3220810	886 Taiwan

1 to 2 of 2

APPENDIX 5 Q&A

For more details about Q&A, please visit our official website: www.eagleeyesctv.com/supp_QnA.aspx.

Question	Answer
<p>I can connect to this camera in my house or office where it's installed with wireless network.</p> <p>But when I leave my house or office, I can't connect to it from my mobile phone (with 3G network), or other PC (connected to Internet). Why?</p>	<p>You didn't configure this camera to Internet, but only in LAN.</p> <p>Please follow the steps in the advanced network setup guide downloadable from www.surveillance-download.com/user/m357a.swf to complete network configurations, or it's recommended for you to check with your local installer or reseller for this service because it's usually hard for a person who doesn't have network knowledge to set network configurations.</p>
<p>My live images are not fluent. Why?</p>	<p>Image fluency could be affected by the local network upload bandwidth, router efficiency, client network download bandwidth, complexity of live view, and more.</p> <p>(Recommended) To have the best image fluency, select QVGA; to have the best image quality, select "SXVGA" based on the model you have; to have normal image fluency and quality, select "VGA".</p>
<p>The live video keeps flickering. Why?</p>	<p>Please try adjusting the power line frequency to "60 Hz" or "50 Hz" for the camera.</p> <p>For iPhone users, access the camera, and select "" on the top right corner to enter IPCAM Configuration page. Then, go to "Advance Setup" → "Camera" to change setting.</p> <p>For access from Internet Explorer, log into the camera, and select "Config." → "Camera" → "Camera".</p>

APPENDIX 6 RECORDING TIME TABLE

Below shows the estimated total recording time for each recording resolution.

The recording time per resolution is the average value collected from the both alarm trigger conditions indicated in “Testing Environment”, and is for reference only.

The time may vary depending on the resolution, image quality & frame rate you choose, the complexity of your monitoring area, and how often the moving objects show in your monitoring area.

Testing Environment

- Place: Office
- Monitoring area: 1.5 meters away from the camera
- Alarm trigger conditions:
 - (1) One person walks by the monitoring area and leaves immediately.
 - (2) Two persons walk by the monitoring area. One goes away immediately, and the other one stays a while and goes away.

Recording Resolution	SXGA	VGA	QVGA
Recording time (second)	25	115	211